

THINKWARE DASH CAM™

X800

User Guide

This product records videos while the vehicle is operating.

Read and follow the instructions in this guide to properly use and maintain the product.

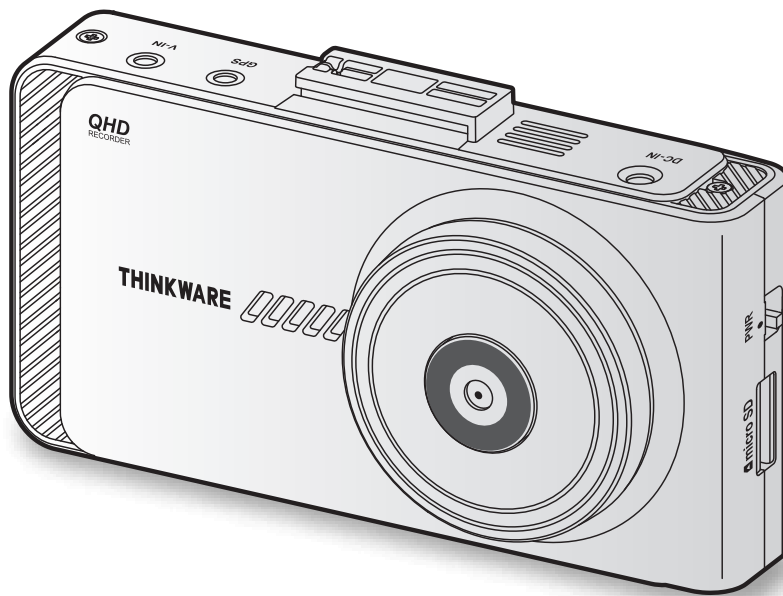

Before using the product

About the product

This product records videos while the vehicle is operating. Use this product only for reference when investigating incidents or road accidents. This product is not guaranteed to record or process cloud data for all events. The device may not record accidents with impacts that are too minor to activate the impact sensor or accidents with massive impacts that cause the vehicle's battery voltage to deviate.

Video recording does not begin until the product is completely turned on (booted up). To ensure that all vehicle events are recorded, wait until the product is completely booted up after turning it on, and then begin operating the vehicle.

THINKWARE is not responsible for any loss caused by an accident, nor is it responsible for providing any support regarding the outcome of an accident.

Depending on the vehicle's configuration or operating conditions, such as the installation of remote door lock devices, ECU settings, or TPMS settings, some product features may not be supported, and different firmware versions may influence the product's performance or features.

About the user guide

The information provided in the guide may change when the manufacturer updates its service policy. This user guide is intended for THINKWARE X800 models only, and it may contain technical errors, editorial errors, or missing information.

Copyrights

All rights for the content and maps in this guide are reserved by THINKWARE and are protected under copyright laws. All unauthorized duplication, revision, publication, or distribution of this guide without written consent from THINKWARE is prohibited and is eligible for criminal charges.

Registered trademarks

THINKWARE X800 is a registered trademark of THINKWARE.

Other product logos and service names in this guide are trademarks of the relevant companies.

Turning voice recording ON or OFF

Some jurisdictions may prohibit recording voice in the vehicle or may require that all passengers have knowledge of the recording and provide consent before you record voice in the vehicle. It is your responsibility to know and follow all laws and restrictions for your jurisdiction.

The device can record voice using the integrated microphone while recording video. Voice recording is ON by default. Please refer to the manual to turn voice recording on or off at any time.

FCC Compliance Statement

This device complies with part 15 of the FCC Rules. Operation is subject to the following two conditions: (1) This device may not cause harmful interference, and (2) this device must accept any interference received, including interference that may cause undesired operation.

FCC Statement

This equipment has been tested and found to comply with the limits for a Class A digital device, pursuant to part 15 of the FCC Rules. These limits are designed to provide reasonable protection against harmful interference when the equipment is operated in a commercial environment. This equipment generates, uses, and can radiate radio frequency energy and, if not installed and used in accordance with the instruction manual, may cause harmful interference to radio communications. Operation of this equipment in a residential area is likely to cause harmful interference in which case the user will be required to correct the interference at his own expense.

FCC Caution

Any changes or modifications (including the antenna) made to this device that are not expressly approved by the manufacturer may void the user's authority to operate the equipment.

Responsible Party – U.S. Contact Information

- Company Name : Thinkware Systems USA Inc.
- Company Address : 18021, Sky Park Circle, STE J2, Irvine, CA, 92614, USA
- E-mail : support@thinkware.com

Contents

Safety information	5	4. Using Advanced Driver Assistance Systems (ADAS) (optional)	29
1. Product overview	8	4.1 The lane departure warning system (LDWS)	30
1.1 Included items	8	4.2 The forward collision warning system (FCWS)	31
1.1.1 Standard items	8	4.3 The urban forward collision warning system (uFCWS)	32
1.1.2 Accessories (sold separately)	8	4.4 The front vehicle start alert (FVSA)	32
1.2 Part names	9	5. Settings	33
1.2.1 Front camera (main unit) - front view	9	5.1 Setting the camera	33
1.2.2 Front camera (main unit) - rear view	10	5.2 Setting recording features	33
1.2.3 Rear camera (optional)	10	5.3 Setting Advanced Driver Assistance Systems (ADAS)	34
1.3 Removing and inserting the memory card	11	5.4 Configuring the system settings	35
2. Installing the product	12	6. Accessing the product information	36
2.1 Installing the front camera (main unit)	12	6.1 Understanding the product features	36
2.1.1 Selecting an installation location	12	6.2 Viewing the product information	36
2.1.2 Securing the product	12	6.3 Accessing and configuring the GPS	36
2.1.3 Connecting the power cable	14	7. Using the PC viewer	37
2.2 Installing the rear camera (optional)	17	7.1 System requirements	37
2.2.1 Selecting an installation location	17	7.2 Learning about the PC viewer	37
2.2.2 Securing the rear camera	18	7.2.1 Installing the PC viewer	37
2.2.3 Connecting the rear camera cable	19	7.2.2 PC viewer screen layout (for Windows)	38
2.3 Installing the external GPS module (optional)	20	7.2.3 Playing recorded videos on the PC viewer (for Windows)	39
3. Using recording features	21	7.2.4 PC viewer screen layout (for Mac)	40
3.1 Turning the product on or off	21	7.2.5 Playing recorded videos on the PC viewer (for Mac)	41
3.2 Turning the LCD on or off	21	8. Troubleshooting	42
3.3 Learning about LED indicators and file storage locations	21	9. Specifications	43
3.4 Using the continuous recording feature	22		
3.5 Recording manually	22		
3.6 Using parking mode	23		
3.7 Using the Super night vision feature	24		
3.8 About the screen layout	25		
3.8.1 Live view screen	25		
3.8.2 Home screen	26		
3.9 Playing the videos	27		

Safety information

Read the following safety information to properly use the product.

Safety symbols in this guide



"Warning" - Indicates a potential hazard which, if not avoided, may result in injury or death.



"Caution" - Indicates a potential hazard which, if not avoided, may result in minor injury or property damage.



"Note" - Provides useful information to help users better utilize the product's features.

Safety information for proper use

Driving and product operation



- **Do not operate the product while driving a vehicle.** Distraction while driving may cause accidents and result in injury or death.
- **Install the product in places where the driver's view is not obstructed.** Obstruction of the driver's vision may cause accidents and result in injury or death. Check with your state and municipal laws before mounting the product to the windshield.

Power supply



- **Do not operate or handle the power cable with wet hands.** Doing so may result in electrocution.
- **Do not use damaged power cables.** Doing so may result in electrical fire or electrocution.
- **Keep the power cable away from all heat sources.** Failure to do so may cause the power cord insulation to melt, resulting in electrical fire or electrocution.
- **Use the power cable with the correct connector and make sure the power cable is connected securely and is firmly in place.** Failure to do so may result in electrical fire or electrocution.
- **Do not modify or cut the power cable.** Also, do not place heavy objects on the power cable or pull, insert, or bend the power cable using excessive force. Doing so may result in electrical fire or electrocution.



- **Use only genuine accessories from THINKWARE or an authorized THINKWARE dealer.** THINKWARE does not guarantee compatibility and normal operation of third-party accessories.
- **When connecting the power cable to the product, ensure that the connection between the cable plug and the power cable connector on the product is secure.** If the connection is loose, the power cable may become disconnected due to vehicle vibration. Video recording is not available if the power connector is disconnected.

Children and pets



- **Ensure that the product is out of the reach of children and pets.** If the product breaks, it may result in fatal damage.

Other information about the product

Product management and operation



- **Do not expose the product to direct sunlight or intense light.** The lens or internal circuitry may fail otherwise.
- **Use the product at a temperature between 14°F and 140°F (-10°C to 60°C) and store the product at a temperature between -4°F and 158°F (-20°C to 70°C).** The product may not function as designed and some permanent physical damages may result if it is operated or stored out of the specified temperature ranges. Such damages are not covered by the warranty.
- **Frequently check the product for the proper installation position.** Impact caused by extreme road conditions may alter the installation position. Ensure that the product is positioned as instructed in this guide.
- **Do not apply excessive force when pressing the buttons.** Doing so may damage the buttons.
- **Do not use chemical cleaners or solvents to clean the product.** Doing so may damage plastic components of the product. Clean the product using a clean, soft, and dry fabric.
- **Do not disassemble the product or subject the product to impact.** Doing so may damage the product. Unauthorized disassembly of the product voids the product warranty.
- **Handle with care.** If you drop, mishandle, or expose the product to external shocks, it may cause damage and/or result in the malfunction of the product.
- **Do not attempt to insert foreign objects into the device.** Doing so may damage the product.
- **Avoid excessive humidity and do not allow any water to enter the product.** Electronic components inside the product may fail if exposed to humidity or water.



- Depending on the make and model of your car, the power may be constantly supplied to the dash cam even when the ignition is turned off. Installation of the device to a continuously powered 12V outlet could result in vehicle battery drainage.
- This device is designed to record video while the vehicle is in operation. The quality of the video might be affected by weather conditions and the road environment, such as whether it is day or night, presence of street lighting, entering/exiting tunnels, and the surrounding temperature.
- THINKWARE is NOT responsible for the loss of any recorded video during operation.
- Although the device was designed to withstand high-impact car collisions, THINKWARE does not guarantee the recording of accidents when the device is damaged as a result of the accident.
- Keep the windshield and camera lens clean for optimal video quality. Particles and substances on the camera lens or windshield may reduce the quality of the recorded videos.
- This device is intended to be used inside the vehicle only.

1. Product overview

1.1 Included items

Ensure that all the items are included when you open the product box.

1.1.1 Standard items



Front camera
(main unit)

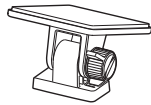

Mount

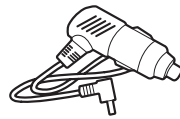

Car charger



MicroSD
memory card



Warranty/
CS information



The standard items may change without prior notice.

1.1.2 Accessories (sold separately)

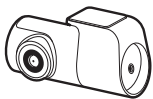

Rear camera



Hardwiring cable



Rear camera cable

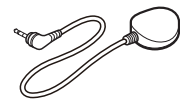

External GPS receiver



- GPS reception may be affected by interference from the vehicle's windshield, particularly those treated with anti-UV protective coating, or built-in defroster. It is recommended that an external GPS receiver is used when the GPS signal is weak or when you cannot get a GPS signal.
- To connect the external GPS receiver to the front camera, carefully remove the front camera's GPS port cover with a pry tool or a small flat-head screwdriver to access the port.

1.2 Part names

1.2.1 Front camera (main unit) - front view

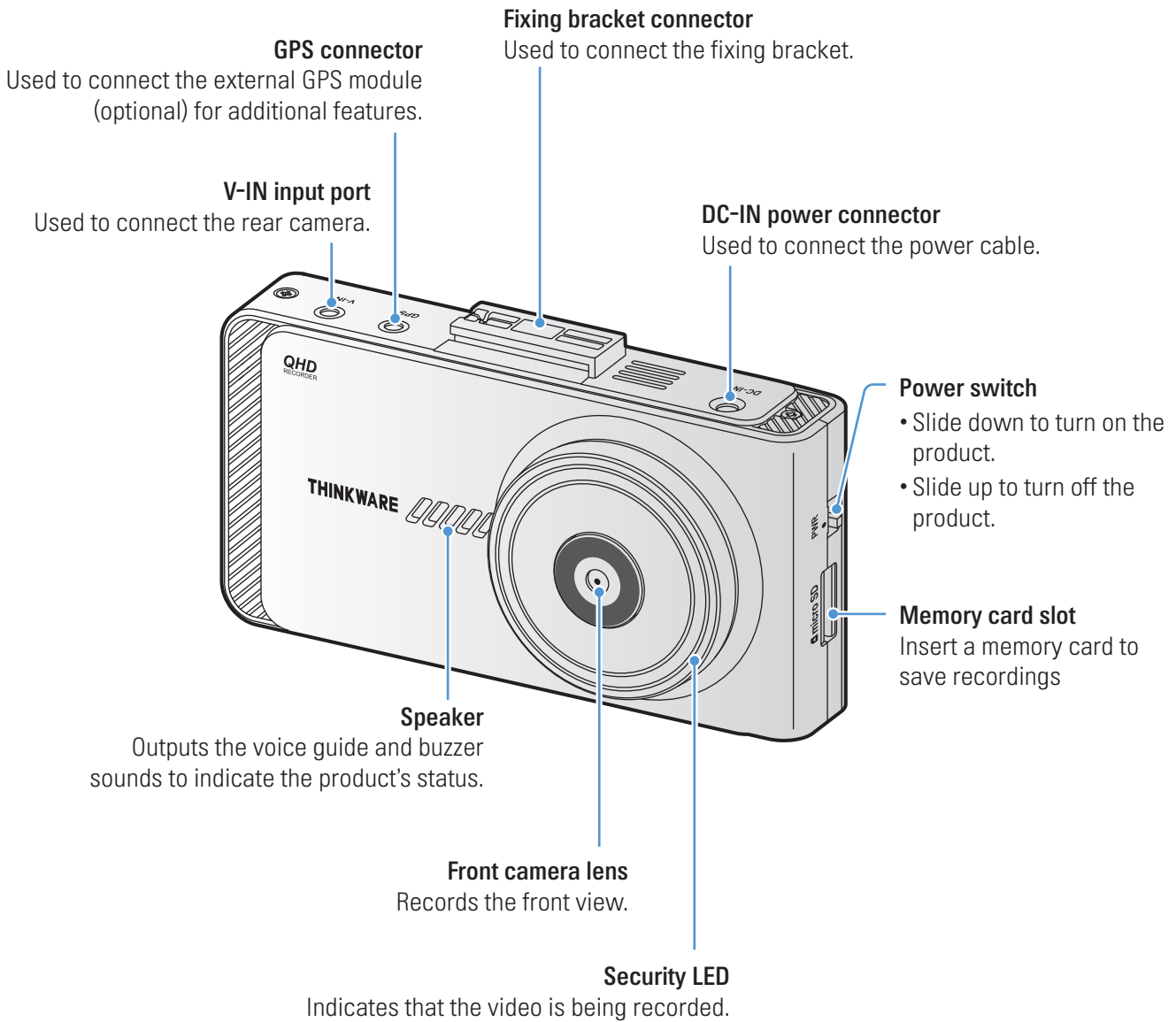

1.2.2 Front camera (main unit) - rear view

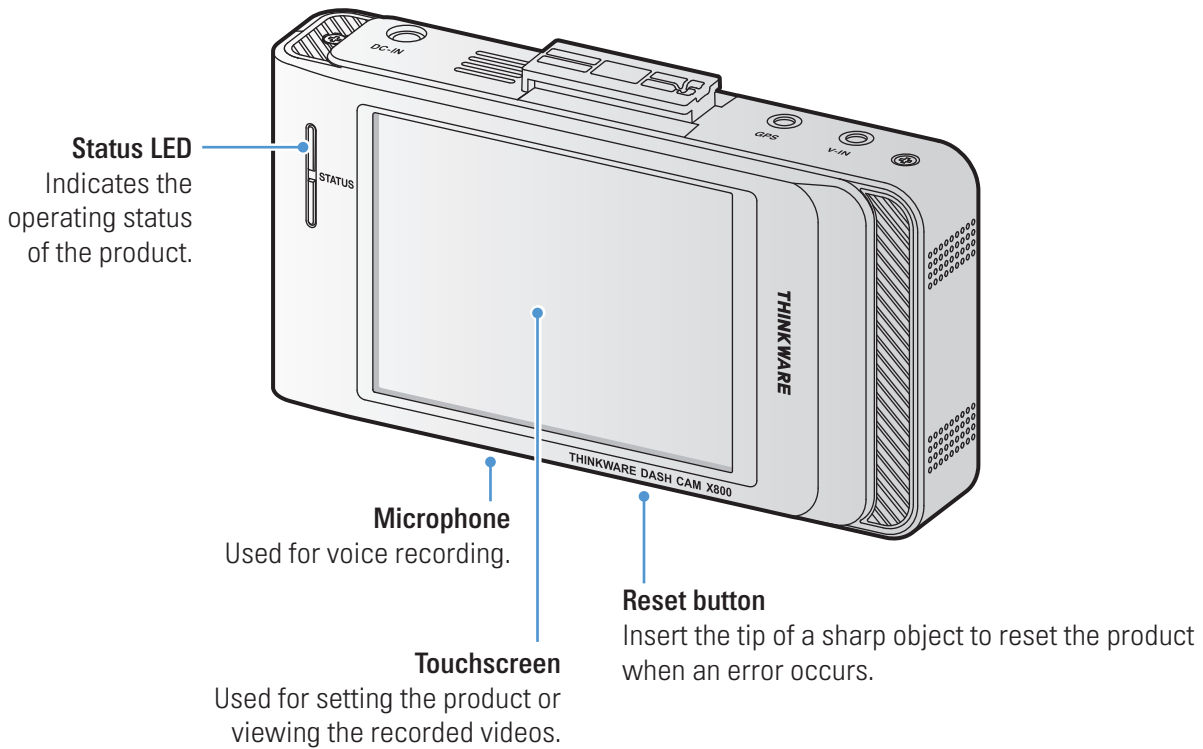

Gently touch the screen to make inputs on the touchscreen. The screen may be damaged if you apply excessive force to the screen or if you touch the screen with a sharp object.

1.2.3 Rear camera (optional)

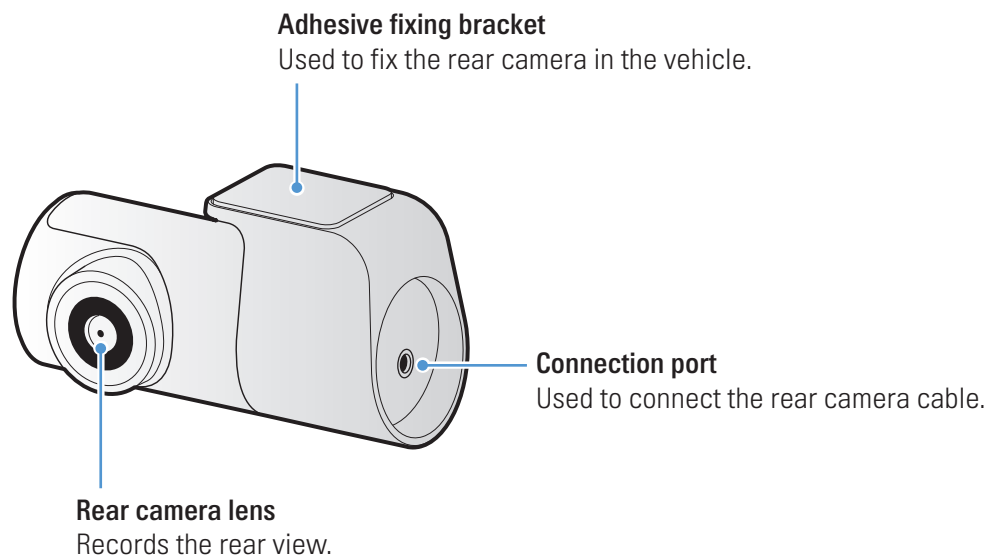

1.3 Removing and inserting the memory card

Follow the instructions to remove the memory card from the product or to insert the memory card into the product.

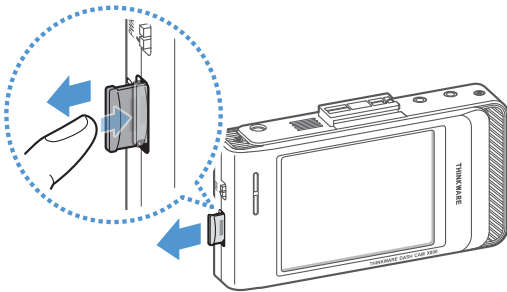

Before removing the memory card, ensure that the product is turned off. Gently push the bottom of the memory card with your fingernail to release it, and then remove it from the product.

To insert the memory card into the memory card slot, ensure that the metal contacts on the memory card are facing toward the lens of the product, and insert it into the slot until you hear a click.



- Ensure that the product is turned off before removing the memory card. The recorded video files may be corrupted or lost if you remove the memory card while the product is on.
- Ensure that the memory card is in the correct direction before inserting it into the product. The memory card slot or the memory card may be damaged if it is inserted incorrectly.
- Use only authentic memory cards from THINKWARE. THINKWARE does not guarantee the compatibility and normal operation of third-party memory cards.



To prevent loss of recorded video files, periodically back up the video files on a separate storage device.

2. Installing the product

2.1 Installing the front camera (main unit)

Follow the instructions to properly install the product.

2.1.1 Selecting an installation location

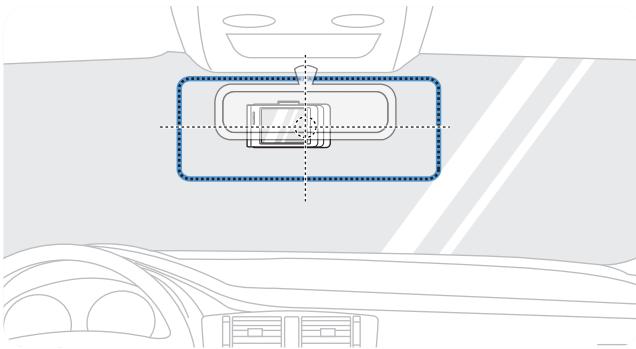

Select an installation location that can record the entire view in front of the vehicle without obstructing the driver's vision. Ensure that the front camera lens is located in the center of the windshield.

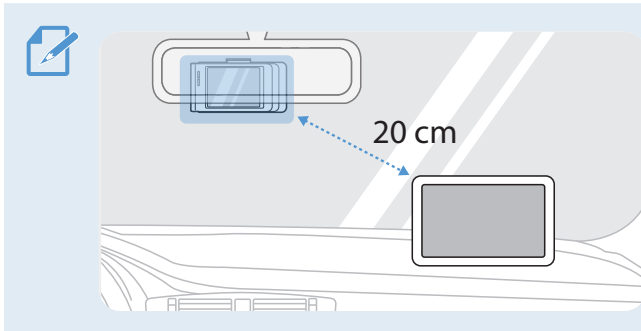

If a GPS navigating device is installed on the dashboard, its GPS reception may be affected depending on the dashboard camera's installation location. Adjust the installation location of the GPS navigating device to ensure that the two devices are separated by at least 20 centimeters (approximately 8 inches).

2.1.2 Securing the product

Follow the instructions to secure the product at the installation location.

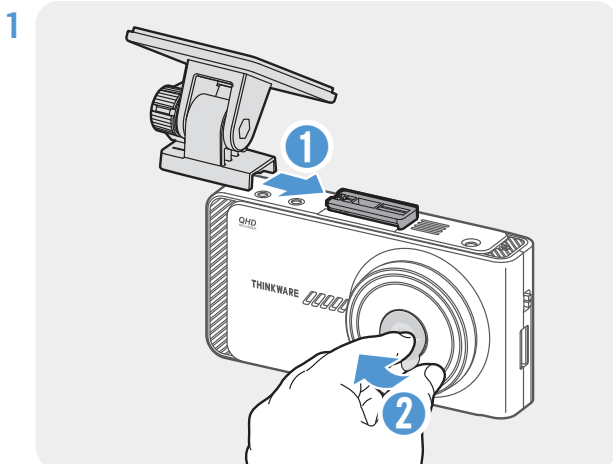

Align the mount to the mount rail on the product, and then slide it until you hear a click (1). Then, carefully remove the protective film (2).

2 After determining the installation location, wipe the installation location on the windshield with a dry cloth.

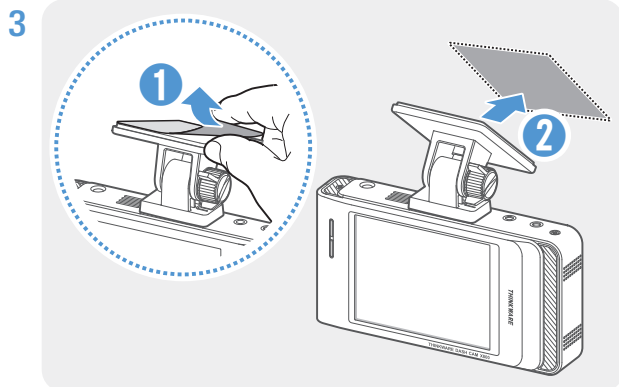

Remove the protective film from the adhesive mount, and then press the mount to the installation location.

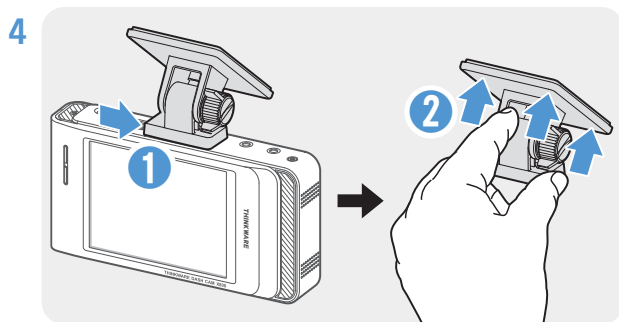

Remove the product from the mount and push the mount against the windshield to ensure that the mount is firmly fixed.

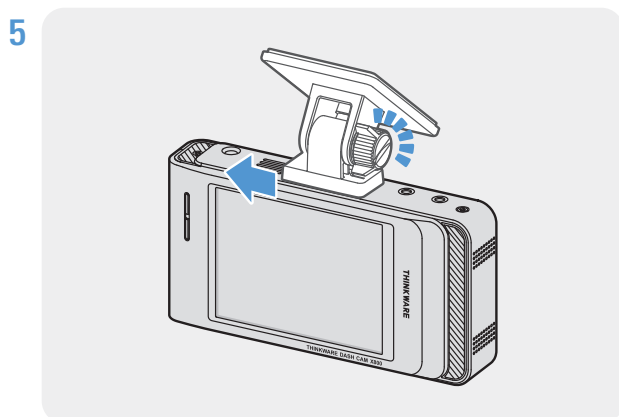

Align the product to the mount, and then slide it into the locking position until you hear a click.



- The product may fall and be damaged during vehicle operation if it is not firmly fixed to the mount.
- If you need to remove the mount from the windshield to alter the installation location, be careful not to damage the windshield's film coat.

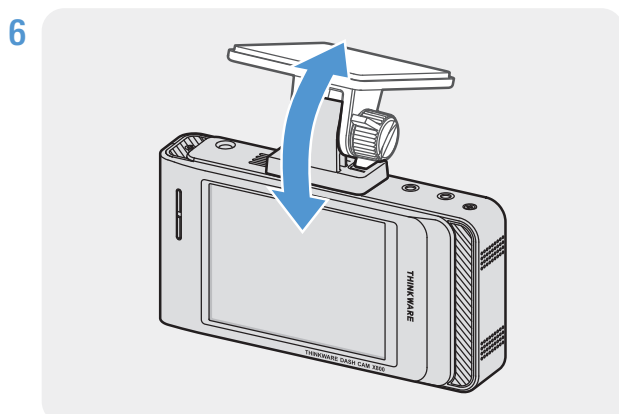

Set the vertical angle of the camera appropriately.

The camera angle must be adjusted again after the installation is complete. Do not completely tighten the fixing screw yet.

2.1.3 Connecting the power cable

When the engine and electrical accessories are turned off, connect the car charger or the continuous power cable (optional) to the product.

Connecting the car charger

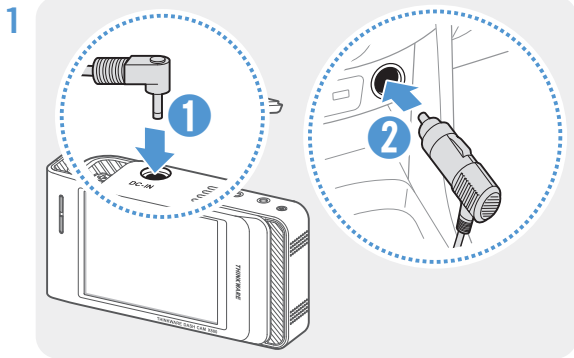

Connect the car charger to the product's DC-IN power port and insert the cigar jack into the vehicle's power socket.



The location and specifications of the power socket may differ by vehicle make and model.



- Use the authentic THINKWARE car charger. Use of third party power cables may damage the product and result in electrical fire or electrocution due to the voltage difference.
- Do not cut or modify the power cable yourself. Doing so may damage the product or the vehicle.
- For safe driving, arrange the cables to prevent the driver's vision from being obstructed or interfering with driving. For more information about arranging cables, visit www.thinkware.com.

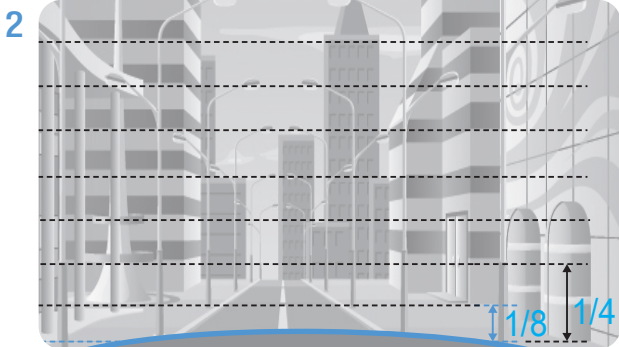

Adjust the camera angle so that the hood of the vehicle covers 1/4 - 1/8 of the screen while viewing the live view on the LCD screen, as shown in the image to the left.

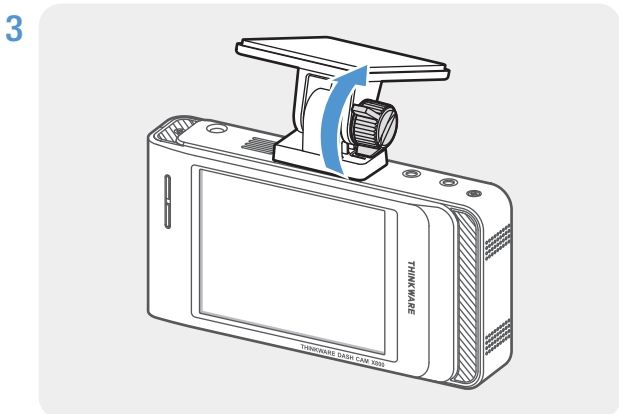

Tighten the screw of the mount firmly.

Connecting the hardwiring cable (optional)

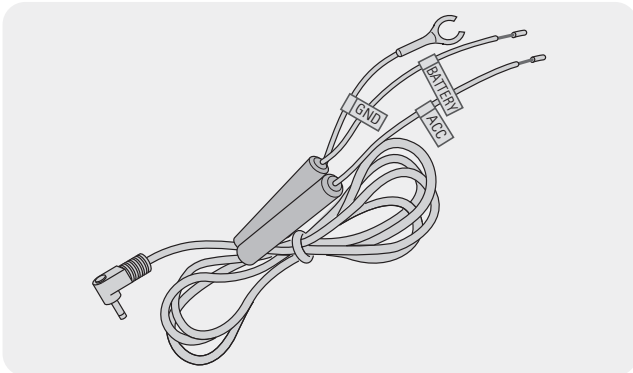

If you connect the product to the vehicle via the hardwiring cable, the camera continues operating even when the vehicle is not operating (parking mode). In parking mode, the camera detects impacts to the vehicle and nearby motion and records video.

For more information about parking mode, refer to "3.6 Using parking mode" on page 23.



- The hardwiring cable must be professionally installed in the vehicle by a trained mechanic. Contact an authorized service center to connect the hardwiring cable to the vehicle. If the product is not installed properly, the product may be damaged or an electrical fire or electrocution may occur.
- Use the authentic THINKWARE hardwiring cable only. Using other manufacturer's cable may damage the product or cause electrocution due to the voltage difference.
- When connecting the hardwiring cable, pay special attention to wiring. If the wires are connected incorrectly, the product or the vehicle may be damaged.

1

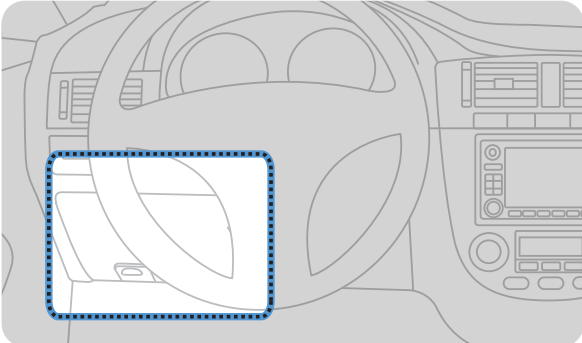

Find the vehicle's fuse box. Usually the fuse box is installed under the driver's seat.



The location of the fuse box may differ depending on the make and model of the vehicle. For more information, refer to your vehicle's owner's manual.

2

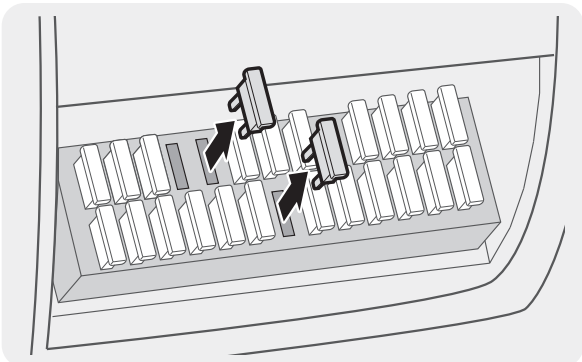

Open the fuse box, find the continuous power terminal (which supplies power when the vehicle is off) and the ACC terminal (which supplies power when the ignition status is "ACC ON") by using an electrical tester, and detach the fuses from the terminals.

3

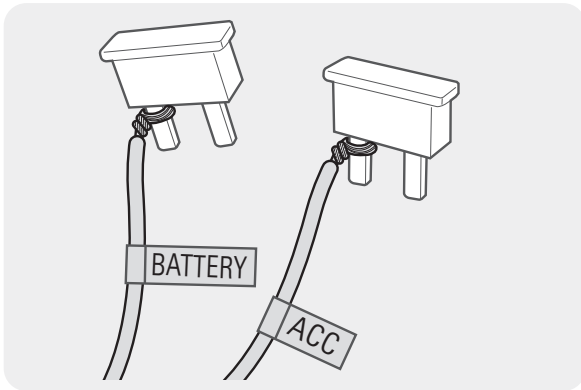

Connect the BATTERY wire to a fuse leg of the continuous power terminal and connect the ACC wire to a fuse leg of the normal (ACC) terminal.

4 Check the fuse panel's input and output contact points by using an electrical tester.

5 Place the fuses back into their locations on the fuse panel, connecting each fuse leg with the wire to the output contact point and taking care not to change the fuse position.



When you install the fuses on the fuse panel, the fuse legs for the BATTERY wire and the ACC wire must be connected to the output terminals respectively. If the fuse leg with the wire is connected to an input terminal, the product or vehicle may be damaged or electrical fire may result.

6

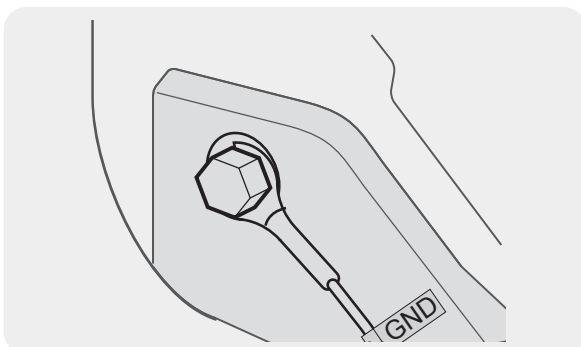

Connect the ground wire (the GND wire) to a bolt attached to a metallic part of the vehicle's body.



Normally, the metallic bolt that you can connect the ground wire to (the GND wire) is fitted nearby fuse box or the driver seat's door interior.

7

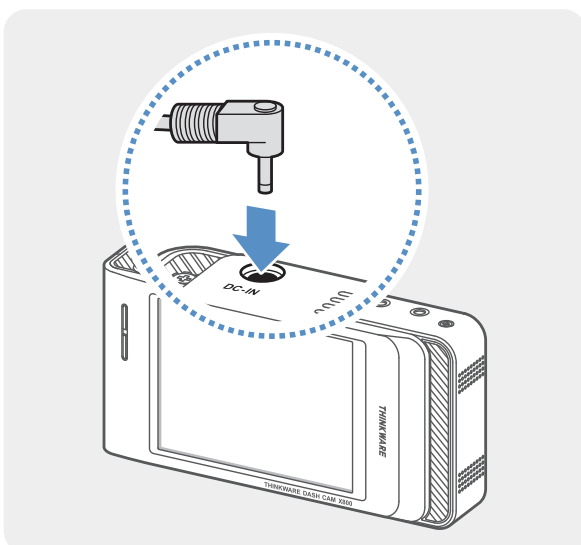

Connect the hardwiring cable to the product's DC-IN power connector and start the engine to make sure the product operates normally.

Once the product is powered on, the LED indicator and the voice guidance are turned on.

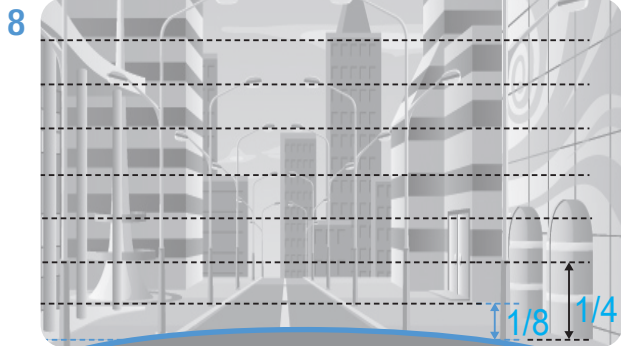

Adjust the camera angle so that the hood of the vehicle covers 1/4 - 1/8 of the screen while viewing the live view on the LCD screen, as shown in the image to the left.

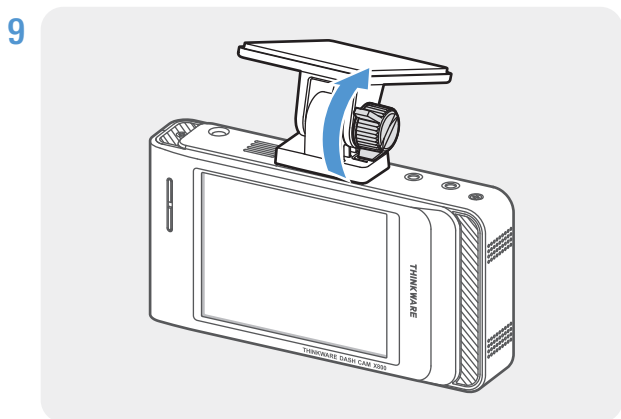

Tighten the screw of the mount firmly.

2.2 Installing the rear camera (optional)

Refer to the following instructions to properly install the rear camera.

2.2.1 Selecting an installation location

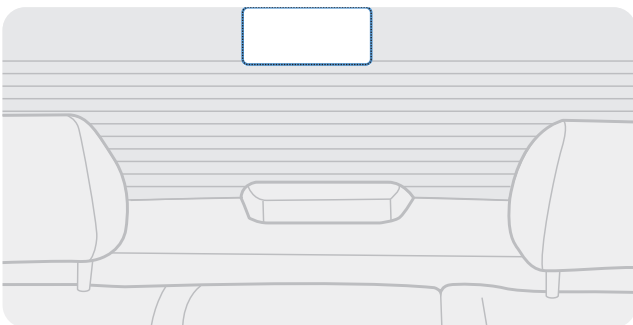

Select a location on the rear windshield where there is no defrost grid wire and the camera can record the entire rear view.



- For vehicles with a sunshade attached to the rear windshield, you must select a location where using the sunshade will not interfere with camera operation.
- The adhesive part of the rear camera should not touch the defrost grid.

2.2.2 Securing the rear camera

Refer to the following instructions to secure the product to the installation location.

- 1 After determining the installation location, wipe the installation surface of the windshield with a dry cloth.



Check the installation location before you secure the rear camera to the rear windshield. After securing the rear camera to the windshield, it is hard to remove the camera or change the installation location due to the strong adhesive.

2

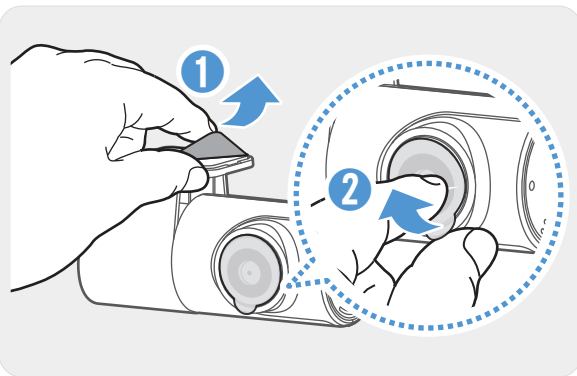

Remove the protective film from the adhesive mount and camera lens.

3

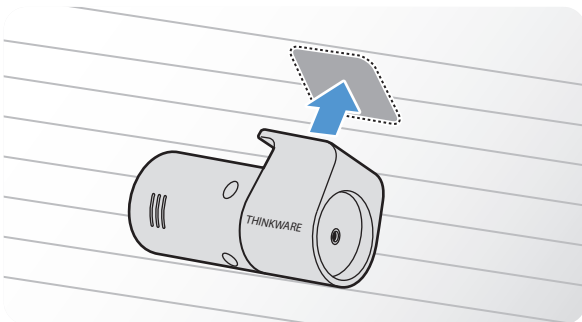

Attach the product with the THINKWARE logo facing indoors and press the adhesive tape firmly to secure the camera.



If the product is fixed in reverse, the rear view will be recorded upside down.

4

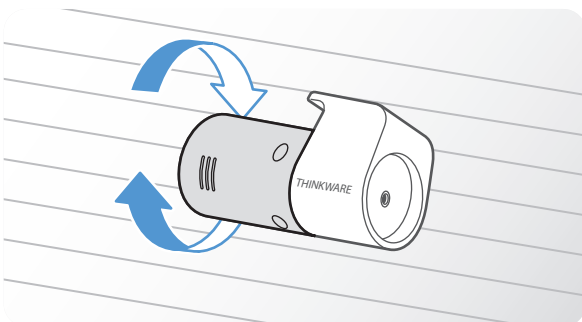

Adjust the camera's vertical angle.

2.2.3 Connecting the rear camera cable

Power off the product and connect the rear camera cable to the front camera (main unit).

1

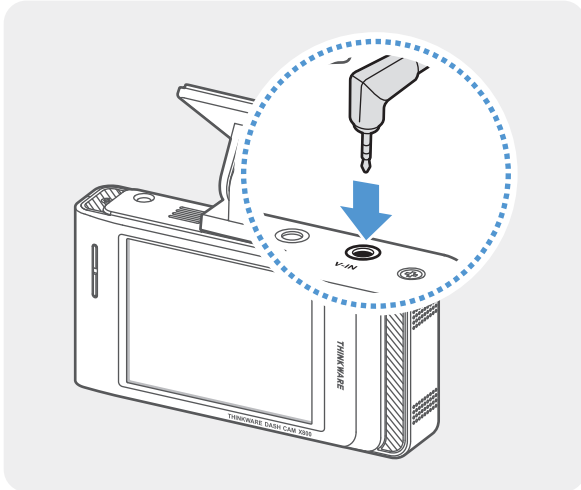

Connect one end of the rear camera cable to the front camera's V-IN port.

2

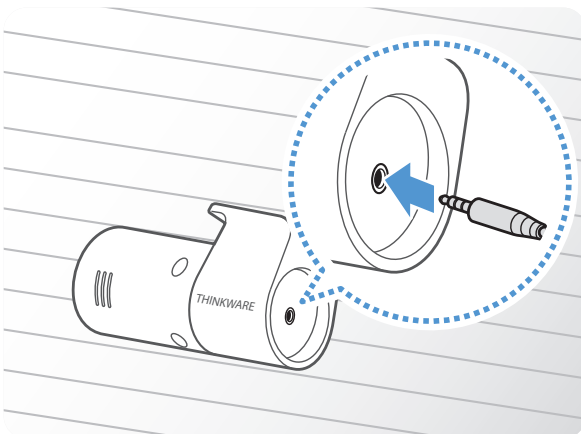

Connect the other end of the rear camera cable to the rear camera's connection port.



For safe driving, arrange the cables to prevent the driver's vision from being obstructed or interfering with driving.

3 Turn on the ACC or start the engine to check if the product is powered on. After the product is powered on, the voice guidance will be turned on.



The product is powered on when the ACC mode is turned on or when the engine starts.

2.3 Installing the external GPS module (optional)

To activate the ADAS features or record driving information (the speed and location), follow the instructions and install the external GPS module on the upper part of the front windshield. Install the external GPS module near the product, taking the module's cable length into account.

1

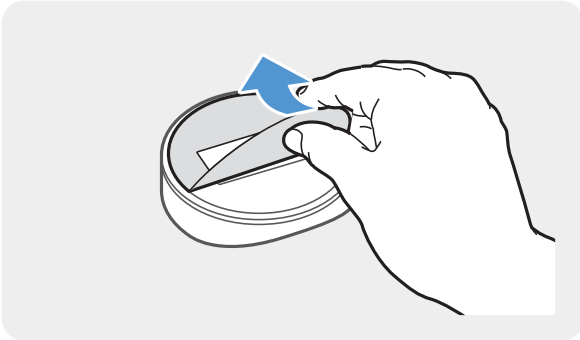

Remove the film from the back of the external GPS module.

2

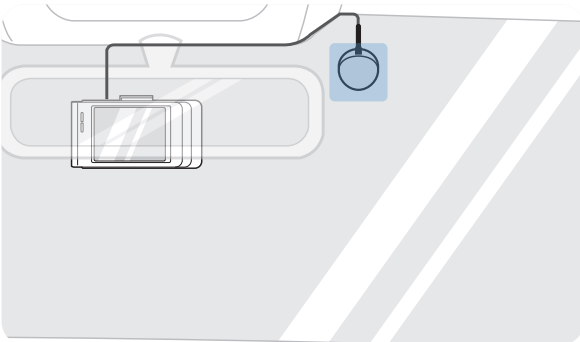

Attach the external GPS module's adhesive surface to the upper part of the front windshield and press the adhesive part firmly to secure it.



Before installation, make sure the external GPS module's cable length is sufficient and check the cable routing path.

3

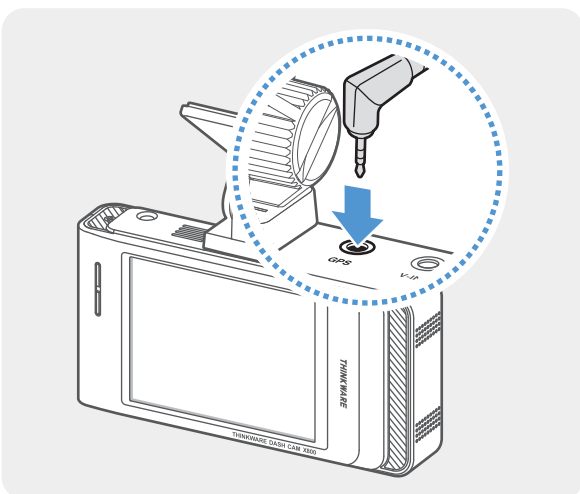

Connect the external GPS module to the product's GPS connector.



Check the GPS connector location again before connecting the module. If you connect the external GPS module to the DC-IN power connector, the pins inside the port may be damaged.

4 Turn on the ACC or start the engine to check that the product is powered on. After the product is powered on, the Status LED and the voice guide are turned on.

3. Using recording features

3.1 Turning the product on or off

The product is turned on automatically and continuous recording starts when you turn on the ACC or start the engine.



- Wait until the product is completely booted up after turning it on, and then begin operating the vehicle. The video recording does not begin until the product is completely turned on (booted up).
- If you want to turn off the product, slide up the Power switch. To turn the power on again, slide down the Power switch.

3.2 Turning the LCD on or off

This product allows you to check recorded videos in real time on the LCD display by supporting the live view feature.

You can set the time that the LCD will turn off automatically. Tap the Home menu () button on the Live view screen > **Settings** > **System Settings**, and select the desired time from **LCD Auto-Off**.

LCD Auto-Off option	Operation description
30 sec. (default)	The LCD will turn off automatically if you do not operate the product for 30 seconds.
1 min.	The LCD will turn off automatically if you do not operate the product for 1 minute.
10 min.	The LCD will turn off automatically if you do not operate the product for 10 minutes.
OFF	The LCD is always on.

3.3 Learning about LED indicators and file storage locations

LED indicators

You can check the operating status, even when the LCD is turned off, by checking the LED indicators on the rear of the product.

For more information about what the LED indicates in each recording mode, refer to the corresponding section of the recording mode (the continuous recording, the manual recording, and parking mode recording).

Video file storage location

Videos are stored in the following folders according to their recording mode. The folder names displayed on the screen and created in the memory card are as follows.

On the product screen	Continuous	Continuous Impact	Parking recording	Parking Impact	Manual Recording	Saved Videos
PC monitor (in the memory card)	Driving	Driving_Shock	Parking	Parking_Shock	Manual	Safety_Box





Play videos on the product or a computer only. If you play videos by inserting the memory card in devices such as a smartphone or a tablet PC, the video files may be lost.

3.4 Using the continuous recording feature

Connect the power cable to the product's DC-IN power port and then turn on the vehicle's electrical accessories or start the engine. The LED indicators and the voice guide are turned on, and the continuous recording starts.

When the Live view screen is displayed, the continuous recording will start automatically.

Mode	Operation description	Status LED (STATUS)
Continuous recording	During driving, videos are recorded in 1 minute segments and stored in the Continuous folder.	 (light on)
Incident continuous recording*	When an impact to the vehicle is detected, a video is recorded for 20 seconds, from 10 seconds before the detection to 10 seconds after the detection, and stored in the Continuous Impact folder.	 (flickers)

* When an impact to the vehicle is detected during continuous recording, incident continuous recording starts with a buzzer sound.



Wait until the product is completely booted up after turning it on, and then begin operating the vehicle. The video recording does not begin until the product is completely turned on (booted up).



- When incident continuous recording starts, the buzzer sounds as a notification.
- To use all recording modes, you must insert a memory card into the product.

3.5 Recording manually

You can record a scene you want to capture while driving and store it as a separate file. Manually recorded videos are stored in the **Manual Recording** folder to prevent important data loss due to insufficient storage.

To start manual recording, tap the manual recording (📹) button on the live view screen. Then, manual recording will start with the voice guide.





Mode	Operation description	Status LED (STATUS)
Manual recording	When you tap the manual recording (📹) button, a video will be recorded for 10 seconds before to 50 seconds after pressing the button, and stored in the Manual Recording folder.	 (flickers)

To watch a manually recorded video, tap the Home menu (🏠) button on the Live view screen > **File List** > **Manual recording**, and select a video to play.

3.6 Using parking mode

When the product is connected to the vehicle via the continuous power cable, the operating mode is switched to parking mode with the voice guide after the engine or electrical accessories are turned off. (Default)

If you do not want to use parking mode or you want to change the mode settings, on the Live view screen, tap Home menu (🏠) button > **Settings** > **Rec. Settings**. Refer to the following table to set the **Parking Mode** options.

Option		Operation description	Status LED (STATUS)
Motion Detection	No motion or impact detected	Monitors movement in the area or impacts to the vehicle. Video will be recorded only when motion or an impact is detected.	 (flickers slowly)
	Motion detected	When a moving object is detected while parking, a video is recorded for 20 seconds, from 10 seconds before detection to 10 seconds after detection, And stored in the Parking recording folder.	 (flickers quickly)
	Impact detected	When an impact is detected while parking, a video is recorded for 20 seconds, from 10 seconds before detection to 10 seconds after detection, and stored in the Parking Impact folder. (The buzzer will sound.)	 (flickers quickly)
Time Lapse	No impact detected	A video is recorded at a rate of 2 fps for 10 minutes, compressed into a 2-minute long file, and stored in the Parking recording folder. Since the video file recorded with this option is small, you can record a long video.	Off
	Impact detected	When an impact is detected while parking, a video is recorded for 100 seconds at a rate of 2 fps, from the moment 50 seconds before detection to 50 seconds after detection, and stored in the Parking Impact folder after being compressed into a 20-second long file. (The buzzer will sound.)	 (flickers quickly)

Option		Operation description	Status LED (STATUS)
Energy saving	No impact detected	Monitors movement in the area or impacts to the vehicle while parking. Video will be recorded only when impact is detected.	Off
	Impact detected	When an impact is detected while parking, a video is recorded for 20 seconds from within 1 second after detection and stored in the Parking Impact folder. (The buzzer will sound.)	 (flickers quickly)
OFF		The product is powered off when electric accessories and the engine are turned off.	Off



If parking mode settings are changed, the videos in the **Parking recording** folder will be deleted. (The videos in the **Parking Impact** folder will not be deleted.) To prevent data loss, back up all parking mode videos before changing parking mode settings



- You cannot use Motion Detection, Time Lapse, or Energy Saving at the same time.
- Parking mode operates only when the continuous power cable is connected. For more information about connecting to the continuous power cable, refer to "Connecting the continuous power cable (optional)".
- Depending on the battery charging status of the vehicle, the duration of parking mode may differ. If you want to use parking mode for an extended period, check the battery level to prevent battery depletion.
- You can record bright and high resolution videos while parking at night by activating the Super night vision feature.

3.7 Using the Super night vision feature

With the Super night vision feature, you can record videos that are brighter than videos recorded without this feature. The Super night vision feature is enabled by image signal processing (ISP) to improve the definition of videos recorded while driving or parking at night.



⟨When Super night vision is deactivated⟩



⟨When Super night vision is activated⟩

- 1 To activate the Super night vision feature, tap the Home menu () button on the Live view screen > **Settings** > **Rec. Settings**, and then tap the setting button next to **Super Night Vision**.
- 2 Select a check box of **Continuous Mode** or **Parking Mode** (or both) to apply the Super night vision feature.

3.8 About the screen layout

The followings are layout descriptions of the live view and home screens.

3.8.1 Live view screen

On the Live view screen, you can view the currently recorded video and operate the product by tapping on the LCD display. When you turn on electrical accessories and start the engine, the Live view screen will be displayed.



Wait until the product is completely booted up after turning it on, and then begin operating the vehicle. The video recording does not begin until the product is completely turned on (booted up).



If you set LCD Auto-off to OFF, the screen will be kept on, and power consumption will increase.

3.8.2 Home screen

You can move to the Home screen by tapping the Home menu (🏠) button on the Live view screen.

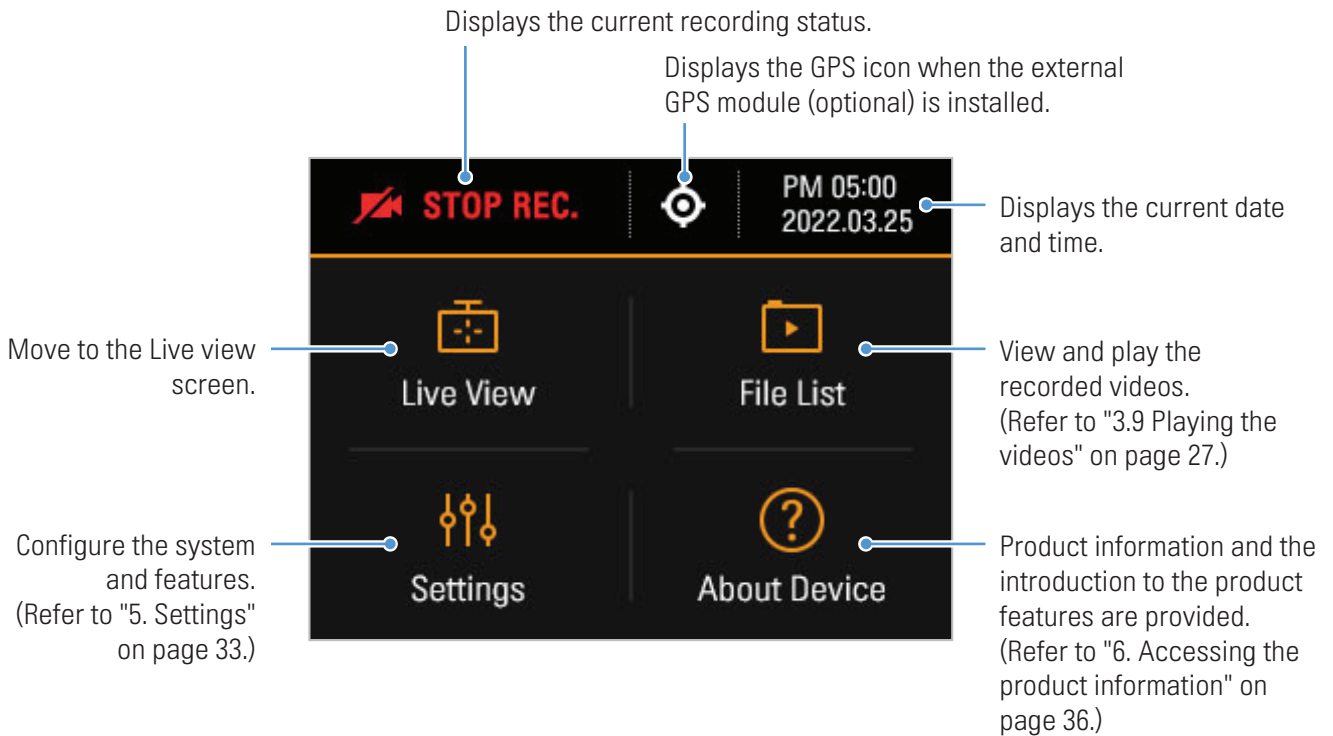

*optional



- Stop your vehicle in a safe location before operating the product.
- While operating the home screen, the product will stop recording.
- Play videos on the product or a computer only. If you play videos by inserting the memory card in devices such as a smartphone or a tablet PC, the video files may be lost.

3.9 Playing the videos

You can play and watch recorded videos on your product. Follow the instructions to play the videos.

- 1 On the Live view screen, tap the Home menu (🏠) button > **File List**. The number of videos categorized by the recording mode will be displayed.

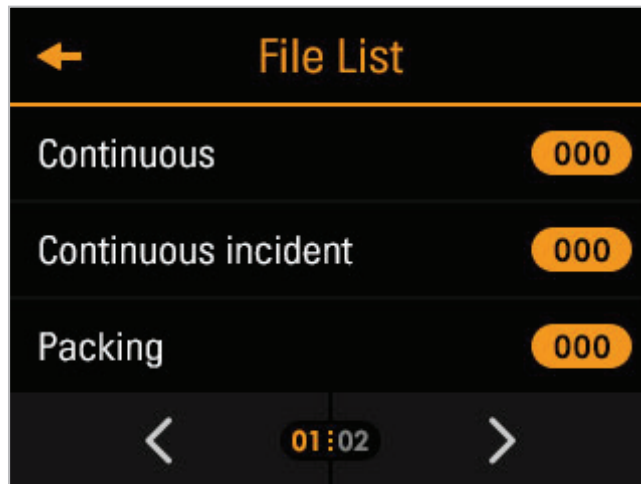

- 2 When you select a category, the video file list will appear. Select the video you want to play.

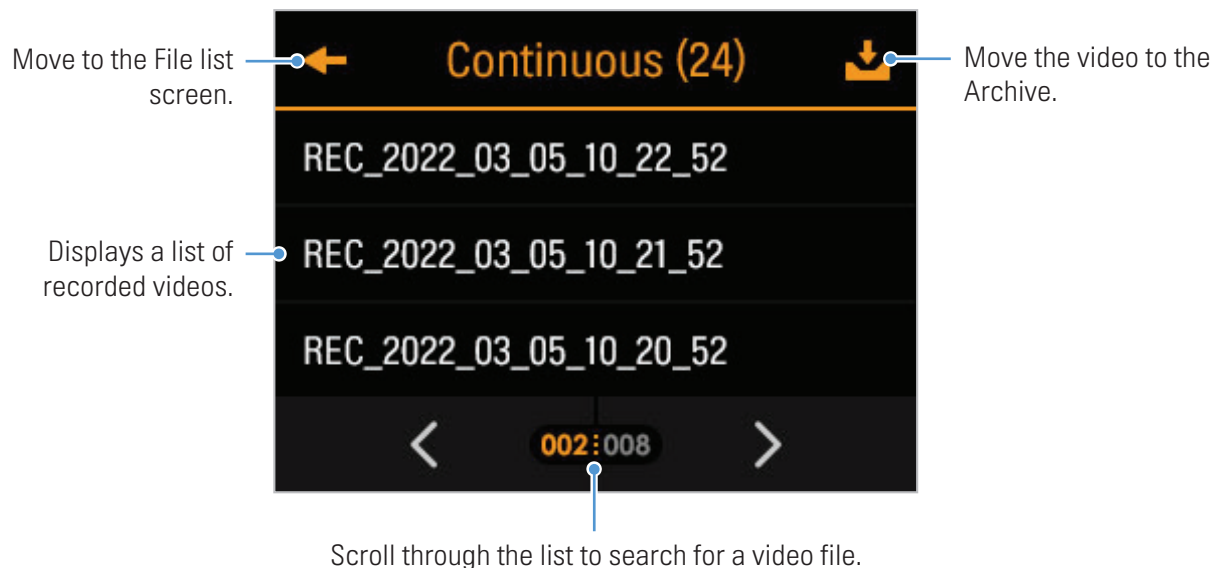

3 Tap a button on the playback screen to control the video player or other functions.

 If you touch the playback area of the LCD display, the screen will be switched to full screen mode. To exit full screen mode, touch the screen again.



Annotations for the playback screen:

- Move to the File list screen. (Arrow pointing left)
- Switch to the rear camera video view. (Rear camera icon)
- Videos are played here. Tap the screen to hide or display the Menu buttons. (Main video area)
- Displays the playback status. (Progress bar)
- Turn the video sound on or off. (Speaker icon with 'x')
- Play the previous file. (Double left arrow)
- Play or pause a video. (Play/Pause icon)
- Play the next file. (Double right arrow)
- Magnify the current video by 3 times. (Magnifying glass icon)
- Move the current video to the Archive. (Download icon)

Additional icons and their functions:

- : Move in the selected direction
- : Close the magnification screen



-  While you are checking the video file list or playing a video, the product will stop recording.
- Play videos on the product or a computer only. If you play videos by inserting the memory card in devices such as a smartphone or a tablet PC, the video files may be lost.
- During playback, vehicle license numbers may not be identified due to the relative speed of a vehicle or lighting conditions.

 A file name is composed of the recording start date and time, and the recording option.

YYYY_MM_DD	HH_MM_SS	
REC_2022_07_01	10_25_30	F.MP4
REC_2022_07_01	10_25_30	R.MP4

Recording conditions

- F: Front camera
- R: Rear camera

- If the memory card storage gets shortened while recording, the previously recorded videos are deleted for storage sufficiency. To prevent data loss, back up important videos on additional storage devices.
 - When the **continuous recording storage is insufficient**: The oldest continuous recording file will be deleted and replaced with a new video file. Event video files (incident recording and manual recording files) will not be deleted.
 - **When the storage is insufficient (for event video files only)**: Event video files will be deleted chronologically from oldest to most recent.

4. Using Advanced Driver Assistance Systems (ADAS) (optional)

ADAS supports a lane departure warning system (LDWS), a forward collision warning system (FCWS), an urban forward collision warning system (uFCWS), and a forward vehicle start alarm (FVSA).

To use ADAS, you must install the external GPS module (to provide vehicle location and operation information). For more information, refer to "2.3 Installing the external GPS module (optional)" on page 20.



Use the authentic THINKWARE GPS module (optional). If you use another manufacturer's cable or GPS module, the product may be damaged or result in electrical fire or electrocution due to the voltage difference.

Identifying the vehicle type

On the Live view screen, tap the Home menu (🏠) button > **Settings > Road Safety Settings**, and then select a **Vehicle Type** among **Sedan / SUV / Truck (Bus)** under **ADAS Features**.

Setting the ADAS settings (auto calibration)

To enhance the ADAS feature's accuracy, follow the instructions to set the alignment on the ADAS settings screen.

- 1 On the Live view screen, tap the Home menu (🏠) button > **Settings > Road Safety Settings**, and then tap **View** next to **ADAS settings** under **ADAS Features**.

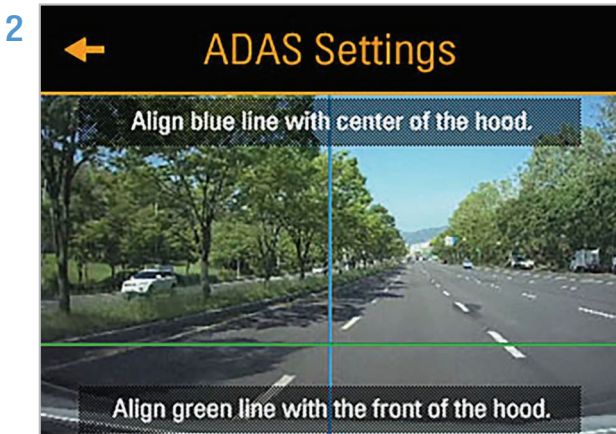

Adjust the product to align the blue line displayed on the ADAS settings screen with the center of the hood and the green line just above the hood. After positioning the product, drive at 30 km/h for more than 1 minute to finish the alignment.



When you align the ADAS settings screen, adjust the product position within 7 cm of the default installation location (where the camera lens is located at the center of the front windshield).

You can use ADAS after the initial setup.

4.1 The lane departure warning system (LDWS)

When the vehicle departs its lane, the LDWS detects the lane departure via the real-time video image and warns the driver.

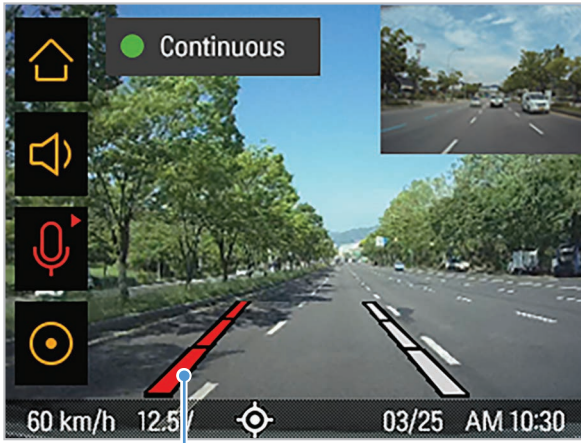

The lane guide lines are displayed on the screen when you activate the LDWS.



The voice guide warns you and a left or right lane guide line will display in red when the vehicle enters either lane.

The departed lane is displayed in red.



The on-screen lane guide lines cannot be aligned. The guide lines may not perfectly match the actual lanes due to the product installation angle, position, or winding roads.

Setting the LDWS

- To deactivate the LDWS, tap the Home menu () button on the Live view screen > **Settings** > **Road Safety Settings**, and then set **LDWS (Lane Departure Warning)** under **ADAS Features** to **OFF**. To set the warning sensitivity, select a sensitivity option (Low / Mid / High).
- To change the lane departure detection speed, tap the Home menu () button on the Live view screen > **Settings** > **Road Safety Settings**, and then select a **LDWS speed** among **50km/60km/70km/80km** under **ADAS Features**.



If the vehicle is driving on a snow-covered road, in the rain at night, or on a damaged road, the LDWS may not work as it does under normal conditions.

4.2 The forward collision warning system (FCWS)

When the vehicle drives at 40 km/h or above, the FCWS will detect forward collision danger via the real-time video image and warn the driver.

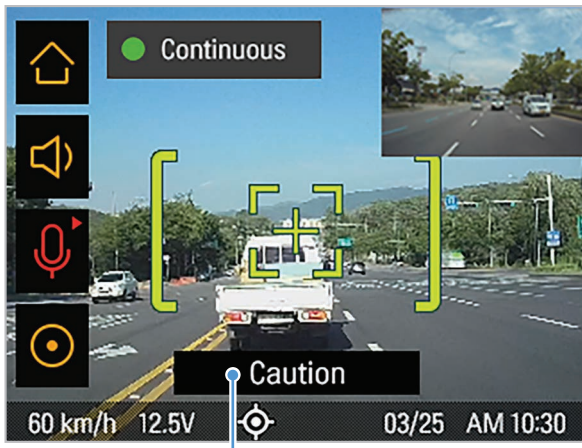

Preliminary forward collision warning: Displayed when a preliminary collision hazard is detected.

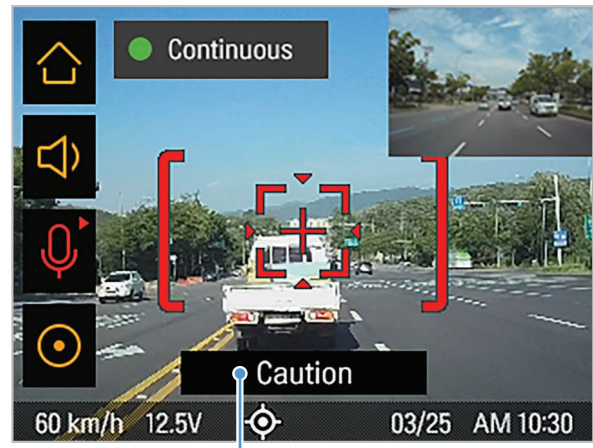

Secondary forward collision warning: Displayed when the distance to the vehicle ahead decreases after a preliminary collision warning.

To deactivate the FCWS or change the warning sensitivity, tap the Home menu () button on the Live view screen > **Settings** > **Road Safety Settings**, and then tap the button next to **FCWS (Forward Collision Warning)** under **ADAS Features** to switch the sensitivity option (**Low/Mid/High**) to set the detection sensitivity, or **OFF** to deactivate the feature.

4.3 The urban forward collision warning system (uFCWS)

When the vehicle drives at 30 km/h or lower, the uFCWS will detect forward collision danger via the real-time video image and warn the driver.

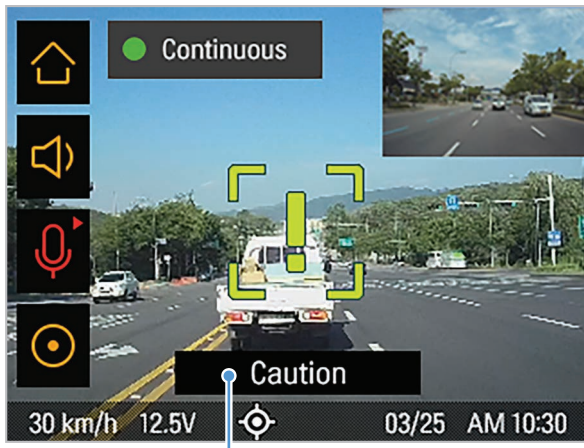

Preliminary low speed forward collision warning:
Displayed when a preliminary low speed collision hazard is detected.

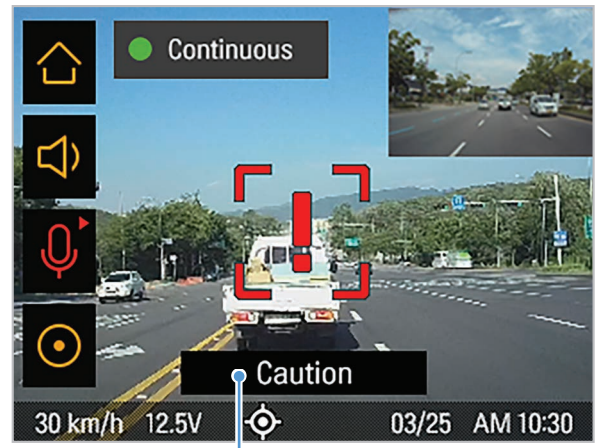

Secondary low speed forward collision warning:
Displayed when the distance to the vehicle ahead decreases after a preliminary low speed collision warning.

To deactivate the uFCWS or change the warning sensitivity, tap the Home menu (🏠) button on the Live view screen > **Settings** > **Road Safety Settings**, and then tap the button next to **Low Speed FCWS** under **ADAS Features** to switch the sensitivity option (**Low/Mid/High**) to set the detection sensitivity, or **OFF** to deactivate the feature.

4.4 The front vehicle start alert (FVSA)

The FVSA will detect the departure of the vehicle in front via the real-time video image and notify the driver.



An alarm is output 4 seconds after the vehicle ahead has departed.

When the vehicle is stopped in traffic, this feature will detect the departure of the vehicle in front and notify the driver.

To deactivate the front vehicle start alarm, tap the Home menu (🏠) button on the Live view screen > **Settings** > **Road Safety Settings**, and then set **FVDW (Front Vehicle Departure Warning)** under **ADAS Features** to **OFF**.

5. Settings

You can set the product features according to your needs and preferences using the settings menu.

5.1 Setting the camera

On the Live view screen, tap the Home menu () button > **Settings** > **Camera Settings** to change the dashboard camera settings.

Setting option	Description
Brightness-Front	Select a brightness level.
Reverse the rear view cam	Select between ON/OFF .

5.2 Setting recording features

On the Live view screen, tap the Home menu () button > **Settings** > **Rec. Settings** to change the recording settings.

Setting option	Description
Cont. Sensitivity	Select between Lowest/Low/Mid/High/Highest .
Super Night Vision	Select between Continuous Mode/Parking Mode
Parking Mode	Select between Motion Detection/Time Lapse/Energy Saving/OFF .
Parking Sensitivity	Select between Lowest/Low/Mid/High/Highest .
Motion Sensitivity	Select between Low/Mid/High .
Off Timer	Select between 6 Hrs./12 Hrs./24 Hrs./48 Hrs./72 Hrs./OFF .
Battery Protection	Select between ON/OFF .
Off Voltage	Select between 12 V/24 V .
Wintertime Battery Protection	Select between Nov/Dec/Jan/Feb/Mar .



- If the continuous impact detection sensitivity is too high, the product will record a video even when a minor impact caused by the road condition and your driving is detected. This may shorten the memory card's life.
- If the continuous impact detection sensitivity is too low, the product may not record a video when a minor accident occurs.



- The vehicle battery will not be charged while the vehicle is parked. If you record in parking mode for an extended period, the vehicle's battery may be depleted and you may not be able to start the vehicle.
- The Off Voltage setting is only available when Battery Protection is set to **ON**.
- If the Off voltage value is too low, the product may consume the battery completely depending on the conditions like the vehicle type or temperature.
- For vehicles using a 12 V battery (most passenger vehicles), set the voltage to **12 V**. For vehicles using the 24 V battery (like most trucks and large vehicles), set the voltage to **24 V**.

5.3 Setting Advanced Driver Assistance Systems (ADAS)

On the Live view screen, tap the Home menu ( button) > **Settings** > **Road Safety Settings** to change the road safety settings.

Setting option	Description
Vehicle Type	Select between Sedan/SUV/Truck (Bus) .
ADAS Settings	Adjust the location of the product according to the guidance on the display.
Initialize ADAS	Tap Initialize ADAS to initialize the calibration settings for the ADAS.
LDWS (Lane Departure Warning)	Select between Low/Mid/High/OFF .
LDWS speed	Select between 50km/60km/70km/80km .
FCWS (Forward Collision Warning)	Select between Low/Mid/High .
Low Speed FCWS	Select between Low/Mid/High .
The front vehicle departure warning	Select between ON/OFF .

5.4 Configuring the system settings

On the Live view screen, tap the Home menu () button > **Settings** > **System Settings** to change the system environment settings.

Setting option	Description
Language	Select between English/Français .
Volume	Select a volume level.
Calibrate Touchscreen	Select the item and calibrate the touchscreen according to the guidance on the display.
LCD Brightness	Select a brightness level.
LCD Auto-off	Select between 30 sec./10 min./Clock/OFF .
Security LED	Select between Up-down/Blink/Random/OFF .
Set Date and Time	Set year, month, and date manually.
Partition Settings	Select between Continuous Recording Priority (recommended)/Impact Recording Priority/Parking Recording Priority/Driving Recording Only .
Use External Battery	Select between ON/OFF .
Format Memory	From the Format Memory menu, tap Format > Confirm .
Reset Settings	From the Reset Settings menu, tap Reset Settings > Reset .



Do not disconnect power or remove the memory card from the product while formatting. Doing so may cause serious damage to the data stored in the memory card.



- If you set **LCD Auto-off** to **OFF**, the screen will be kept on, and power consumption will increase.
- This product has a Format Free 2.0 function. You can save videos for a long time without needing to format the memory card frequently.
- All the data stored in the memory card will be erased after formatting. Tap the Back button () to cancel memory formatting.

6. Accessing the product information

New users may benefit from the basic product information that can be accessed from the Menu screen.

6.1 Understanding the product features

On the Live view screen, tap the Home menu () button > **About Device** > **Functions** to view product features. Brief information about the product's features is displayed on the screen.

6.2 Viewing the product information

On the Live view screen, tap the Home menu () button > **About Device** > **Device Info** to view product information. The following product information and the menus for initializing will be played on the screen.

- Product name
- Firmware version
- Memory capacity

6.3 Accessing and configuring the GPS

A GPS module is used to include the location data in the recorded videos. On the Live view screen, tap the Home menu () button > **About Device** > **GPS Info** to view the GPS features. The connection status, time (UTC), vehicle speed, current elevation, and Horizontal Dilution of Precision (HDOP) are displayed on the screen.

Tap the **Reset** button next to **Reset GPS** to initialize the GPS, and allow it to locate the current position.



Horizontal Dilution of Precision (HDOP)

HDOP is a value that refers to GPS deviation due to satellite positioning.

7. Using the PC viewer

You can view and manage the recorded videos and configure various product features on your PC.

7.1 System requirements

The following are the system requirements for running the PC viewer.

- Processor: Intel Core i5, or higher
- Memory: 4 GB or more
- Operating system: Windows 7 or later (64-bit is recommended), macOS X10.8 Mountain Lion or later
- Other: DirectX 9.0 or higher / Microsoft Explorer version 7.0 or higher



The PC viewer will not operate properly on PC systems running an operating system other than those listed in the system requirements.

7.2 Learning about the PC viewer

7.2.1 Installing the PC viewer



You can download the latest PC viewer software from the THINKWARE website (<https://www.thinkware.com/Support/Download>).

The PC viewer installation file (setup.exe) is stored in the root folder of the memory card that is provided with the product. Follow the instructions to install the PC viewer on your PC.

- 1 Insert the memory card into a memory card reader connected to your PC.
- 2 Move the installation file to the desktop, run it, and complete the installation according to the instructions given in the installation wizard.
After the installation is complete, there will be a shortcut icon to Thinkware Dashcam Viewer.

7.2.2 PC viewer screen layout (for Windows)

The following provides brief information about the PC viewer's screen layout.

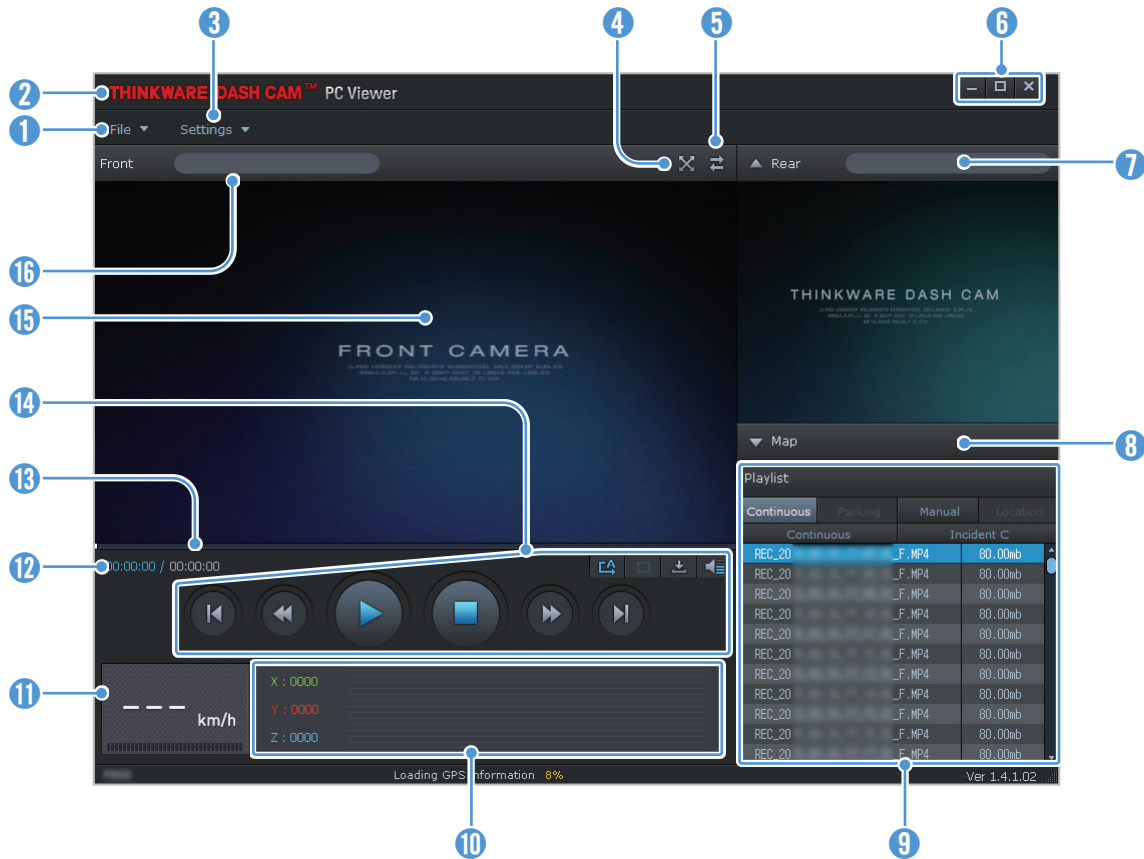

Number	Description
1	Open a file, or save a video with a different name.
2	Visit the THINKWARE website.
3	View or configure the dashcam settings, and set the language for the PC viewer.
4	Display the current video in full screen. Tap the Back (⌫) button to return to the previous screen.
5	Switch between the front and rear videos.
6	Minimize, expand, or close the software.
7	Display the recorded rear camera video.
8	Display the map screen.
9	Displays the playlist.
10	Indicates the G sensor value at the time of recording.
11	Indicates the vehicle's driving speed at the time of recording.
12	Displays the current and total running time of the current video.
13	Displays the progress of video playback.
14	Play or control a video.
15	Displays the current video.
16	Displays the video file name.

7.2.3 Playing recorded videos on the PC viewer (for Windows)

Follow the instructions to play recorded videos.

- 1 Turn off the product and remove the memory card.
- 2 Insert the memory card into a memory card reader connected to your PC.
- 3 Double-click the shortcut to the PC viewer () to open the program. The video files in the memory card will be automatically added to the playlist in the bottom-right corner of the PC viewer screen. The playlist section layout is as follows.

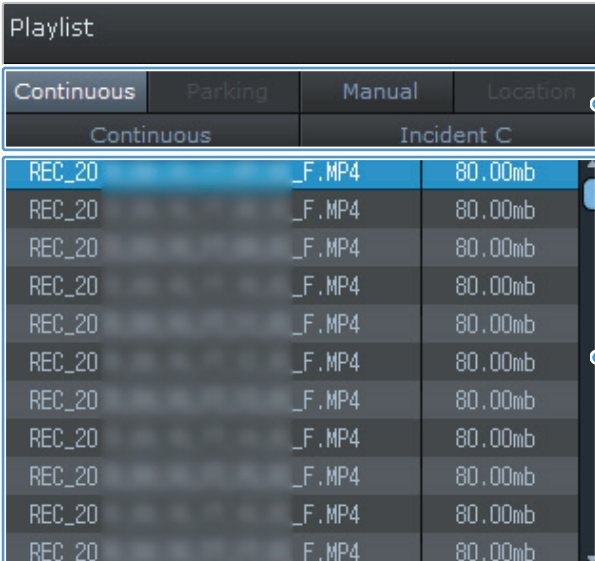

Select a folder.

Incident C		
REC_20	_F.MP4	80.00mb
REC_20	_F.MP4	80.00mb
REC_20	_F.MP4	80.00mb
REC_20	_F.MP4	80.00mb
REC_20	_F.MP4	80.00mb
REC_20	_F.MP4	80.00mb
REC_20	_F.MP4	80.00mb
REC_20	_F.MP4	80.00mb
REC_20	_F.MP4	80.00mb
REC_20	_F.MP4	80.00mb
REC_20	_F.MP4	80.00mb

Displays a list of videos in the selected folder.

- 4 Double-click a video file after selecting a video folder, or click the Play (▶) button after selecting a video file. The selected video file will be played.

 If the video files on the memory card are not automatically added to the playlist when you run the PC viewer, click **File** ▼ > **Open**, select the removable storage device for the memory card, and click **Confirm**.

7.2.4 PC viewer screen layout (for Mac)

The following provides brief information about the PC viewer's screen layout.

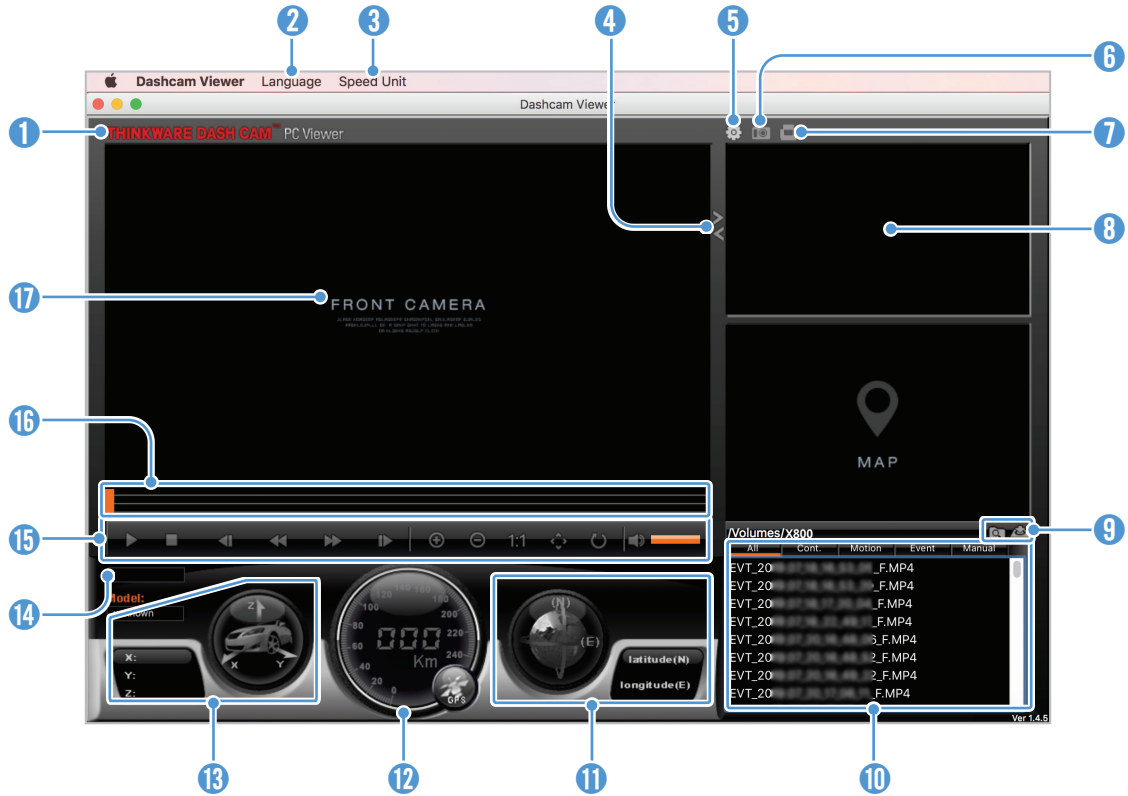

Number	Description
1	Visit the THINKWARE website.
2	Set the language for the PC viewer.
3	Set the speed unit.
4	Switch between the front and rear videos.
5	View or configure the dashcam settings.
6	Save the current scene.
7	Print the current scene.
8	Displays the current rear video.
9	Open a file, or save a video with a different name.
10	Displays the playlist.
11	Displays the GPS information at the time of recording.
12	Indicates the vehicle's driving speed at the time of recording.
13	Indicates the G sensor value at the time of recording.
14	Displays the current and total running time of the current video.
15	Play or control a video.
16	Displays the progress of video playback.
17	Displays the current front video. Right-click this pane to display the current video in full screen.

7.2.5 Playing recorded videos on the PC viewer (for Mac)

Follow the instructions to play recorded videos.

- 1 Turn off the product and remove the memory card.
- 2 Insert the memory card into your Mac using a SD card reader or SD card adapter provided.
- 3 Open the PC viewer.
- 4 Click  and locate the memory card.

The video files in the memory card will be automatically added to the playlist in the bottom-right corner of the PC viewer screen. The playlist section layout is as follows.

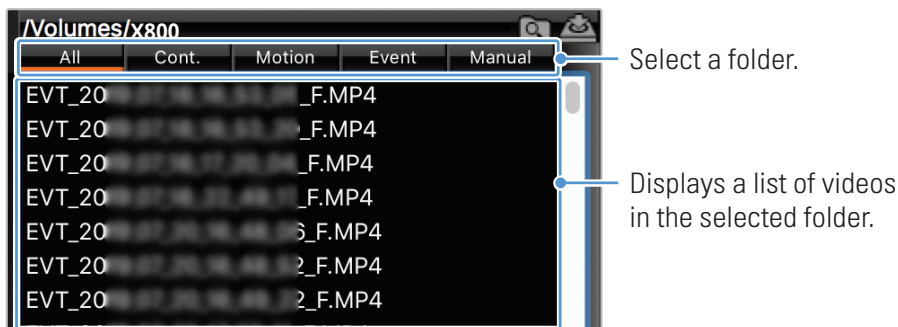

- 5 Double-click a video file after selecting a video folder, or click the Play (▶) button after selecting a video file. The selected video file will be played.

8. Troubleshooting

The following table lists the problems users may encounter while using the product and measures to resolve them. If the problem persists after taking the measures provided in the table, contact the customer service center.

Problems	Solution
Cannot power on the product	<ul style="list-style-type: none">• Make sure the power cable (the optional hardwiring cable or the car charger) is connected to the vehicle and the product properly.• Check the vehicle's battery level.
The product does not operate even when touching the display.	Insert a pin into the Reset button pinhole on the side of the product to reset the product. After resetting the product, the Settings screen and Video playback screen will not disappear.
The voice guide and/or buzzer do not sound.	Check if the volume is set to the minimum.
The video is unclear or hardly visible.	<ul style="list-style-type: none">• Ensure that the protective film on the camera lens has been removed. The video may look unclear if the protective film is still on the camera lens.• Check the installation location of the front or rear camera, turn on the product, and then adjust the camera's viewing angle.
The memory card cannot be recognized.	<ul style="list-style-type: none">• Ensure that the memory card has been inserted in the correct direction. Before inserting the memory card, ensure that the metal contacts on the memory card are facing toward the lens of the product.• Turn off the power, remove the memory card, and then check to ensure that the contacts in the memory card slot are not damaged.• Ensure that the memory card is an authentic product distributed by THINKWARE. THINKWARE does not guarantee compatibility and normal operation of third-party memory cards.
The recorded video cannot be played on a PC.	The recorded videos are stored as MP4 video files. Ensure that the video player installed on your PC supports the playback of MP4 video files.
GPS signal cannot be received.	The GPS signal may not be received in out-of-service areas, or if the product is located between tall buildings. Also, GPS signal reception may not be available during storms or heavy rain. Try again on a clear day at a location that is known to have a good GPS reception. It may take up to 5 minutes until GPS reception is established.

[Before contacting a service center](#)

Please back up all important data stored in the memory card. The data in the memory card may be deleted during repair. Every product requested for repair is regarded as a device that has had its data backed up. The customer service center does not back up your data. THINKWARE is not responsible for any loss, such as data loss.

9. Specifications

To see the product specifications, refer to the following table.

Item	Specification	Remarks
Model name	X800	
Dimension / Weight	100.3 x 55.5 x 29.8 mm	Rear camera: 61 x 27 x 25 mm (optional)
Display panel	2.7" IPS LCD (320 x 240)	
Memory	microSD Memory card (UHS-I)	16 GB / 32 GB / 64 GB
Recording mode	Continuous Rec	Records videos in 1-minute segments (dual channels are supported for recording the front and rear view)
	Incident Rec	Records 10 seconds before and after the incident (total 20 seconds)
	Manual Rec	Records 10 seconds before and after manually starting the recording (total 60 seconds)
	Parking Rec (parking mode)	Requires the hardwiring cable installation
	Energy saving Parking Incident	Records 20 seconds after the event (When an impact occurs on the G-sensor, it detects the part as close as possible to the event point)
	Super Night Vision	Continuous Rec, Parking Rec
	External battery pack interlocking function	Displays i-Volt battery level and charging status (LCD live view)
Camera sensor	SONY Exmor R STARVIS CMOS Sensor	Rear camera: CMOS Sensor
Angle of view	150° (Diagonally)	Rear camera: 160°
Video	QHD (2560 x 1440)@30fps	Rear camera: FHD (1920 x 1080)@30fps
Frame rate	Maximum 30 fps	Front/rear
Audio	PCM (pulse code modulation)	Front/rear
Acceleration sensor	3-axis acceleration sensor (3D, ±3G)	5 levels for sensitivity adjustment available
Rear camera	V-IN port	Micro USB 5-pin connector
GPS	External GPS module (optional)	Supports ADAS features (LDWS, FCWS, uFCWS, FVSA)
EXT. input port	External battery pack (optional)	iVolt Mini External Battery (BAB-50) supported, stereo socket 2.5 Ø / quadropole
Power input	DC 12 / 24 V supported	Rear camera: DC 3.3 V
Power consumption	2CH: 4.7 W / 1CH: 2.7 W (mean)	Except for the fully charged supercapacitor / the LCD OFF status
Auxiliary power unit	Supercapacitor	
LED indicators	<ul style="list-style-type: none"> • Front: Security LED • Rear: Status LED, Rec LED (2 ea) 	
Alarm	Built-in speakers	Voice guide (buzzer sounds)
Operating temperature	14 – 140°F / -10 – 60°C	
Storage temperature	14 – 140°F / -10 – 60°C	

<https://www.thinkware.com>